

LipuSmart-P-OD Extension stage 1

Product information for the product group



ACO Product benefits

- Integrated backflow protection
 - Only one vent stack necessary
 - Compact installation dimensions: The pump technology can be flexibly installed on 3 sides
 - Innovative overall system control via integration in the building control technology
 - 4in1 – complete solution
 - Optional Modbus connection
 - Structural stability of the container with 25-year stability verification according to German Standard DIN 19901
- Odour-free disposal via the connection for direct suction
 - After-cleaning by opening the cover (connected with low odour generation)
 - Disposal connection DN 65, mating flange with Storz coupling 75B and blind connector 2½"

Item Technical Data 3552.66.00

Nominal capacity	Nominal width	Contents			Key data			Weight	
		Sludge trap	Grease store	Overall	Type	P2	To	Empty	Full
		[l]	[l]	[l]		[kW]	[l]	[kg]	[kg]
NS 2	DN 100	210	100	440	Pumpenset 1,5kW	1.5	155	199	639



The LipuSmart pump technology can be flexibly **mounted on 3 sides** of the container.

For more information please visit: <https://www.buildingdrainage.aco/products>

Excluding errors and changes.

Infobox

Item number: 3552.66.00
Version: 18.06.2019
Page 1 of 4

Dimensions

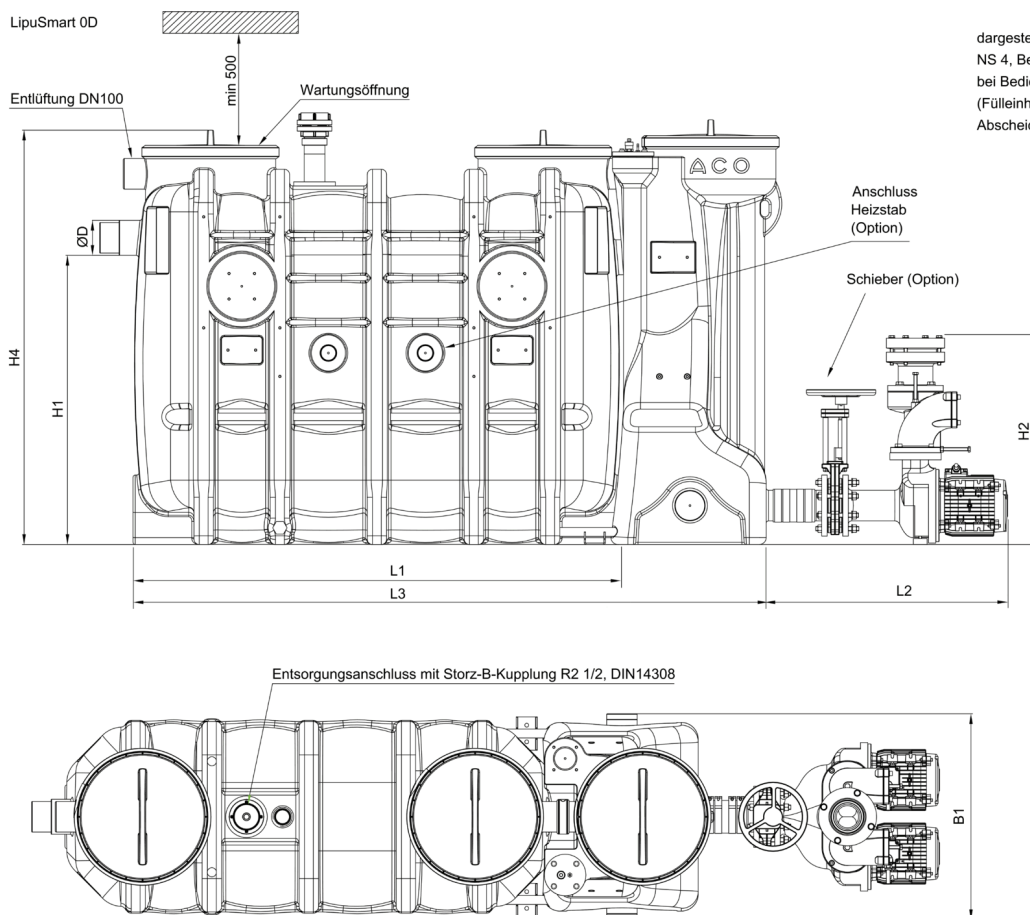

dargestellt:
 NS 4, Bedienungsseite rechts,
 bei Bedienungsseite links sind die Bauteile
 (Füllereinheit, Schauglas) zur Mittelachse des
 Abscheiders spiegelbildlich angeordnet.

Nomi- nal ca- pacity	Dimensions												
	L1	L2	L3	L4	L5	H1	H2	H3	H4	W1	W2	B3	D
	[mm]	[mm]	[mm]	[mm]	[mm]	[mm]	[mm]	[mm]	[mm]	[mm]	[mm]	[mm]	[mm]
NS 2	1100	800	1625	300	680	1055	753	1680	1500	742	880	930	110



The LipuSmart pump technology can be flexibly **mounted on 3 sides** of the container.

For more information please visit: <https://www.buildingdrainage.aco/products>

Excluding errors and changes.

Infobox

Item number: 3552.66.00
 Version: 18.06.2019
 Page 2 of 4

Accessories

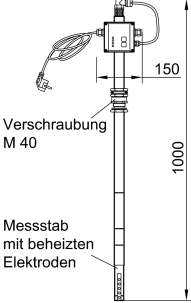
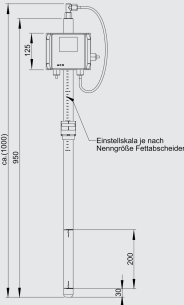
	Description	Used with	Description	Item number
	Grease layer thickness measuring device	<ul style="list-style-type: none"> ■ LipuJet-P <ul style="list-style-type: none"> □ Oval NS 1 – 10 □ Round NS 2 – 20 ■ LipuJet-S <ul style="list-style-type: none"> □ Oval NS 1 – 10 □ Round NS 2 – 20 ■ LipuSmart-P <ul style="list-style-type: none"> □ Oval NS 1 – 10 	<ul style="list-style-type: none"> ■ For electronic measurement of layer of grease ■ Suitable for liquid and/or congealing grease ■ Measuring device with plug and used connecting cable, length: 3 m ■ With two voltage-free changeover contacts to display full warning (80%) and advance warning of fill level (50%) ■ With visual display of fill level ■ With heated probe rod to increase reliability of operation ■ Operating voltage: 230VAC/5 VA ■ Max consumption approx. 12W ■ Weight: 2.8 kg 	3300.11.50
	Grease layer thickness measuring device Multi Control		<ul style="list-style-type: none"> ■ To determine the disposal intervals of grease separators ■ Suitable for liquid and/or hardened fats ■ Delineation with colour-touchpanel ■ Continuous measure in percent ■ With integrated SD-card (4GB) for recording of the measuring process ■ With headed sounding stick (temperature is adjustable) to increase the operation safety ■ Three free of potential contacts for output of pre-alarm (adjustable), full-alarm (adjustable) and error ■ Measuring stick with adjusting scale ■ Delineation with plug-in cable connection, 3 m ■ Service voltage: 100 240VAC 50/60 Hz, 2 A ■ Power: ca. 43 W 	
		LipuJet-P LipuJet-S LipuSmart-P	Weight: 2.7 kg	3300.12.50

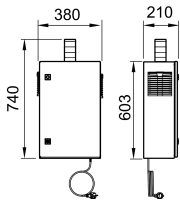
	Description	Used with	Description	Item number
	Smell neutralisation	<ul style="list-style-type: none"> ■ Grease separators (incl. external makes) 	<ul style="list-style-type: none"> ■ Lockable control cabinet <ul style="list-style-type: none"> □ From stainless steel, material grade 304 □ Ground surface □ With side ventilation slots ■ Integrated timer ■ Incl. odour neutralisers: 9 l ■ With dosing pump for reliable discharge ■ Chemical resistant dosing hose ■ Signal column for status monitoring ■ PG gland for on-site connection ■ Control cabinet dimensions: 380 x 600 x 210 mm (W x H x D) ■ System ready to plug in <ul style="list-style-type: none"> □ Incl. cable: 1.5 m ■ 230 V socket to be produced on-site ■ Weight: 36.2 kg 	7980.80.00

You can find further accessories under → <https://www.buildingdrainage.aco/suche/?q=3552.66.00>